

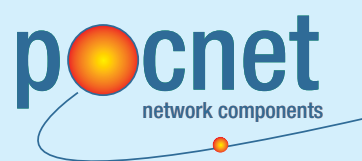

Outdoor Porcelain Terminations



Accessories for high voltage
polymeric cables

About us

Prysmian Cables & Systems is a world-class multinational company. Founded in 1872 as "Ditta Pirelli & C.", it has achieved a leading position for more than a century of operations in its two key international markets - "Energy Cables and Systems" and "Telecom Cables & Systems".

Prysmian Cables and Systems is the world's largest manufacturer of power and telecommunications cables, with 52 manufacturing facilities in 21 countries in five continents and a market share in excess of 10%.

Prysmian Energy Cables and Systems is a global solutions provider, offering a wide range of integrated solutions, such as cable systems, system design and engineering, project management, installation and post-sale services.

Prysmian Energy Cables and Systems concentrates on continuous product innovation and on achieving a competitive edge by focusing on research and development. This is done through Prysmian's own R&D centres and by co-operating with universities, scientific institutions and above all, our customers. Prysmian's world-wide organisation makes and delivers advanced technological solutions to customers anywhere in the world.

Prysmian started manufacturing insulated cables for electric power distribution around 1880 and soon afterwards initiated the development of the first cable accessories.

Prysmian's very long and successful experience in HV and EHV cable systems have lead to the development of a comprehensive range of accessories for extruded dielectric cables.

A relentless R&D effort focused on rubber compounds as well as on electrical design has created accessories for all applications, based on pre-moulded and factory tested joint sleeves and termination stress cones that are recognised worldwide for their unsurpassed reliability.



Stress cone basics

The origin of the current product range of accessories for HV polymeric cables dates back to 1978 when Prysmian, strong of its very long and successful experience in Fluid Filled cable systems developed its first generation of accessories for extruded cable systems.

These accessories are based on pre-moulded electrical components, i.e. stress cones for terminations and one-piece sleeves for joints.

Pre-moulded sleeves and stress cones are currently available for HV polymeric cables from 72.5 kV up to 525 kV and adopt the same design at all voltage classes.

Thanks to its outstanding electrical and mechanical properties, ethylene-propylene rubber (EPR) has been favoured for the rubber mouldings manufacture. After a thorough research on rubber compounds properties, Prysmian developed a proprietary formulation with superior characteristics that is manufactured in-house, which guarantees an unsurpassed reliability of the products.

The mechanical properties of Prysmian special compounds ensure a constant pressure at the cable/moulding interface during the entire lifetime of the accessories, whilst the electrical design has been optimised to minimise the electrical stress concentration in the same area. Prysmian one-piece pre-moulded sleeves and stress cones are completely manufactured in-house.

The moulding process has been refined thanks to the long-standing presence of Prysmian in the rubber industry; each single moulding is mechanically and electrically tested in the factory (the applied electrical test parameters are stricter than those established by the international standards) and certified individually.

Prysmian HV Accessories quality system complies with both ISO 9001 and ISO 14001 standards. Prysmian HV accessories based on EPR mouldings represent a highly reliable solution that is considered a key component in the safe operation of a HV cable system.

The reliability of its HV accessories has made Prysmian the worldwide market leader in terms of design and quality and all major power Utilities consider Prysmian products the benchmark in terms of performance and service.

Product range

Prysmian porcelain termination solutions - based on EPR pre-moulded stress cones - include a wide range of products for the connection of underground circuits and overhead lines. The long-standing experience with porcelain insulators has allowed Prysmian to develop, for each voltage class, a comprehensive range of terminations including several different creepage distances. Furthermore, all pre-moulded stress cones undergo factory testing to check for manufacturing defects. This ensures that, once the termination is assembled, its reliability can be compared to that of the cable it is fitted on.

The pre-moulded stress cones, available for a wide range of cable sizes, are designed to fit with controlled interference over the cable insulation and to follow the cable's diameter variations. At the same time, they guarantee a sufficient positive pressure to control the electric field concentration under any service condition.

The terminations are filled with an insulating compound up to a level where the electric field is substantially reduced. The terminations base plates and the cable's metallic screen are electrically insulated from the supporting structure by means of stand-off insulators, designed to withstand both mechanical and electrical operating stresses.

More than 15,000 of these outdoor terminations have already been installed throughout the world for voltages of between 66 and 400 kV.

> New filling medium

Prysmian's latest development in the field of outdoor terminations is a new type of filling medium that replaces the traditional silicon fluid.

The new patented medium is a special compound that becomes partially solid within a short time after the filling of the termination, thus avoiding any possibility of leakage. Nevertheless, the compound remains sufficiently elastic to withstand even the highest difference in temperature.



Porcelain terminations

available from 72,5 kV up to 525 kV

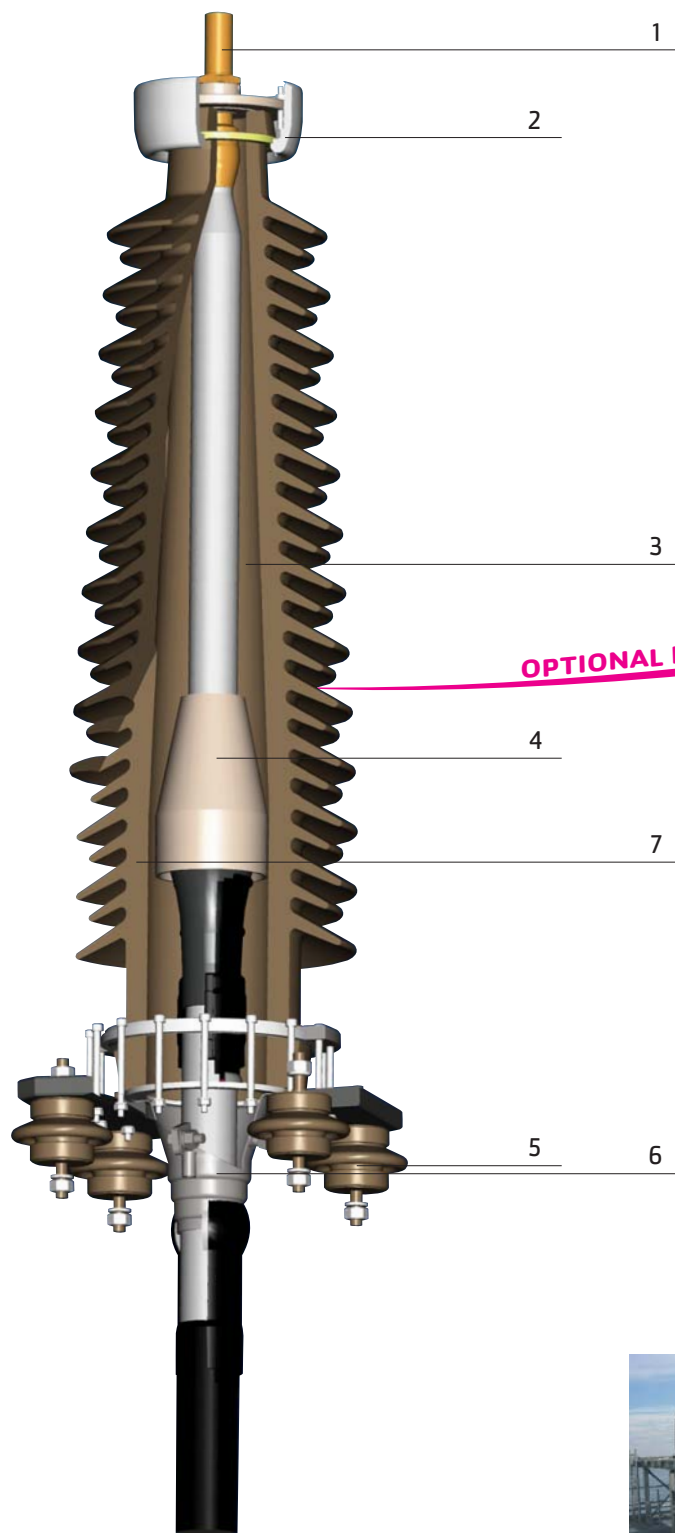

Legend

- 1 OHL connection stalk
- 2 Corona shield
- 3 Filling medium
- 4 Stress cone
- 5 Stand-off insulators
- 6 End bell
- 7 Insulator



YOUR ENERGY... OUR SYSTEMS... ANYWHERE

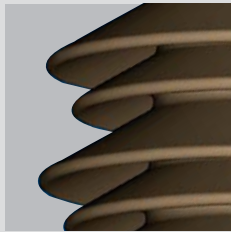

Brown colour

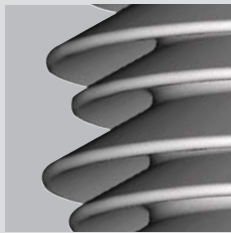

Grey colour

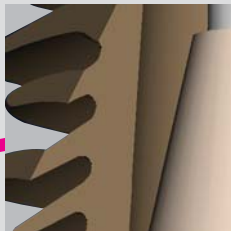

Different filling medium

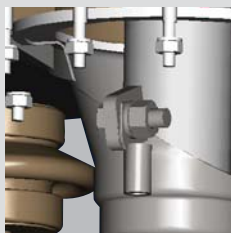

Optical fibres management on request

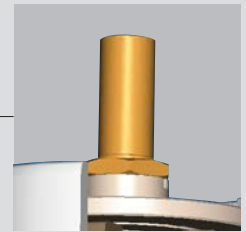

Several OHL connection stalk design / dimensions

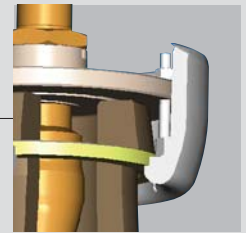

Arching horns available on request

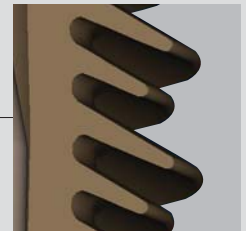

Several creepage distances

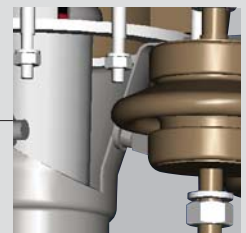

Partial discharge sensor port on request

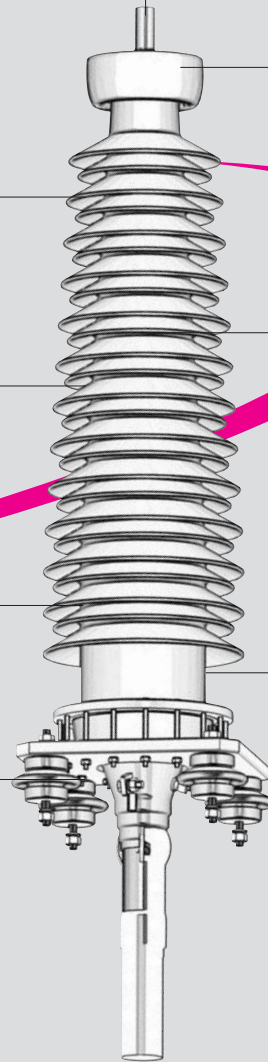

Electrical rating

U max (kV)	72,5 kV	123 kV	145 kV	170 kV	245/300 kV	420 kV
---------------	------------	-----------	-----------	-----------	---------------	-----------

Basic Impulse Level	350	550	650	750	1050	1425
IEEE 48 = 1 min AC Dry withstand	175	205	310	365	460	-
IEEE 48 = 10 sec AC Wet withstand voltage	145	190	275	315	445	-
IEEE 48 = 6 h AC Dry withstand voltage	120	160	210	250	330	-
IEC 60840 - 62067 = 15 min AC Dry withstand	90	160	190	218	320	440
IEC 71-1 = 60 sec AC Dry withstand voltage	140	230	275	325	460	-

ARGENTINA

Prysmian Energía Cables y Sistemas de Argentina S.A.
Fábrica La Rosa, Av.da Argentina 6784,
1439 Capital Federal
tel. +54 11 4630 2000
fax +54 11 4630 2100

AUSTRALIA

Prysmian Power Cables & Systems
Australia PTY LTD
1 Heathcote Road, Locked Bag 7042,
Liverpool Business Centre 1871, NSW
tel. +61 2 9600 0777
fax +61 2 9600 0747

AUSTRIA

Prysmian OEKW GmbH
Lembockgasse 47A,
1230 Wien
tel. +43 1 8667 70
fax +43 1 8667 7109

BRAZIL

Prysmian Energia Cabos e Sistemas do Brasil S.A.
Av. Alexandre de Gusmao 145,
09110-900 Santo André – SP
tel. +55 11 4998 4000
fax +55 11 4998 4811

CHINA

Prysmian Cables & Systems
1505-06, Tower A, City Center of Shanghai,
No. 100 ZunYi Road, Shanghai 200051
tel. +86 21 6237 1411
fax +86 21 6237 1195

EGYPT

Prysmian Cables & Systems
8 Abd El Azim Aoudallah st. Hegaz sq.,
Heliopolis – Cairo
tel. +20 2 2418 557
fax +20 2 6381 327

FINLAND

Prysmian Cables & Systems Oy
P.O. Box 13,
FIN-02401 Kirkkonummi
tel. +358 10 77551
fax +358 9 2982204

FRANCE

Prysmian Energie Cables et Systèmes
France s.a.
Zone Industrielle du PORT AU VIN,
GRON, 89 100 SENS
tel. +33 3 8695 7769
fax +33 3 8695 7781

GERMANY

Prysmian Kabel und Systeme GmbH
Gartenfelder Str. 28,
D 13599 Berlin
tel. +49 30 3675 40
fax +49 30 3675 4640

HONG KONG

Prysmian Cable Systems Pte. Ltd.
Unit A, 18/F, China Overseas Building,
139 Hennessy Road, Wanchai, Hong Kong
tel. +85 2 2827 8308
fax +85 2 2827 7212

HUNGARY

Prysmian MKM Magyar Hungarian Cable
Works Co. Ltd.
Barázda u. 38, H-1116 Budapest
tel. +36 1 3822 222
fax +36 1 3822 202

INDONESIA

PT. Prysmian Cables Indonesia
Gedung BRI II, Suite 1502,
Jln. Jend Sudirman No 44-46,
Jakarta 10210
tel. +62 264 351 222
fax +62 264 351 780

ITALY

Prysmian Cavi e Sistemi Energia Srl
Viale Sarca 222,
20126 Milano
tel. +39 02 6449 9492
fax +39 02 6449 5035

KUWAIT

Prysmian Cables & Systems – Kuwait Office
Villa No 4 (next to Hyatt Regency Hotel),
Bidda – KUWAIT
tel. +965 575 7704
fax +965 572 5780

MALAYSIA

Prysmian Cable Systems Pte. Ltd.
Lot 2 Jalan Kawat 15/18,
40702 Shah Alam, Selangor Darul Ehsan
tel. +60 3 5518 4575
fax +60 3 5511 9590

NETHERLANDS

Prysmian Cables and Systems B.V.
Schieweg 9, 2627 AN Delft
P.O. Box 495, 2600 AL Delft
The Netherlands
tel. +31 15 260 5260
fax +31 15 261 3808

NEW ZEALAND

Prysmian Cables & Systems
71 Hugi Johnson Drive, P.O. Box 12162,
Penrose, Auckland
tel. +64 9 5251 260
fax +64 9 5251 262

NORTH AMERICA

Prysmian Cables & Systems North America
700 Industrial Drive,
Lexington, SC 29072 – USA
tel. +1 803 9511 171
fax +1 803 9511 092

ROMANIA

Prysmian Cabluri si Sisteme SA
Soseaua Draganesti, Km. 4,
0500 Slatina
tel. +40 49 435 699
fax +40 49 433 484

RUSSIA

Prysmian Cables and Systems
4-th str. Vosmogo Marta 6°
building 1, 9-th floor,
Moscow, 125167
tel. +7 495 933-7036
fax +7 495 933-7035

SINGAPORE

Prysmian Cable Systems Pte. Ltd.
No 4 Tuas Avenue 12. 3rd Storey,
639047 Singapore
tel. +65 6862 9866
fax +65 6862 9877

SLOVAKIA

Prysmian Kablo Bratislava
Tovarenska 11,
812 61 Bratislava
tel. +421 7 50211111
fax +421 7 52961773

SPAIN

Prysmian Cables y Sistemas S.L.
Carretera C-15, Km. 2,
08800 Vilanova i la Geltrú (Barcelona),
tel. +34 93 811 6181
fax +34 93 811 6011

THAILAND

Prysmian Cable Systems Pte. Ltd.
555 RASA Tower 11th floor,
Phaholyothin Road, Lardyao, Chatuchak,
Bangkok 10900
tel. +66 2 9370 316
fax +66 2 9370 318

TURKEY

Turk Prysmian Kablo ve Sistemleri A.S.
Buyukdere Caddesi No 117,
34394 Gayrettepe, Istanbul
tel. +90 212 3551 500
fax +90 212 2175 810

U.A.E. (Dubai)

Prysmian Cables and Systems Middle East
P.O. Box 72125,
Dubai
tel. +971 4 345 7870
fax +971 4 345 7101

UK

Prysmian Cables & Systems Limited
P. O. Box 6, Leigh Road,
Eastleigh, Hampshire, SO50 9YE
tel. +44 2380 2955 55
fax +44 2380 2951 11